

Appendix Q

# Trapping Brown-headed Cowbirds to Control Songbird Nest Parasitism



# Trapping Brown-headed Cowbirds

The purpose of this guide is to assist landowners that wish to help songbird reproduction by building and operating a cowbird trap. Please note that all persons wishing to trap cowbirds must be certified through an approved training program before the trap is put into operation. This training is offered at no cost by **Texas Parks and Wildlife (TPW)** and affords the landowner with permit coverage to handle and release non-target birds that may inadvertently enter the trap. All applicable state and federal laws must be observed during the duration of trapping. If questions arise, contact your closest **TPW** office for assistance.

## Why Trap Cowbirds?

Throughout North America songbird numbers are declining. While there is no one single reason for this decline, one major contributing factor is the spread of the brown-headed cowbird. These birds were once limited to the short-grass prairies, where they followed the herds of buffalo, feeding on the insects stirred up by the movement of herds as they moved from place to place. Today however, this highly adaptive bird is found throughout North America. This is a problem because of the reproductive strategies the species employs. The cowbird is what is referred to as a brood parasite. This means the female lays her eggs in the nests of other birds, abandoning them to the care of foster parents. The foster birds raise the cowbird chick to the detriment of their own young. Because the female cowbird can lay as many as 70 eggs per season, susceptible species of songbirds, such as the black-capped vireo and the golden-cheeked warbler, that are already endangered, are particularly at risk.

One of the most effective ways of controlling cowbirds is through trapping. Traps are operated from March 1 through May 31 only. During this time they are checked frequently, preferably every day, and data is collected. Any birds that are not cowbirds that have accidentally been trapped must be released as soon as possible. Female cowbirds are humanely euthanized through cervical dislocation. Males may be released, often after being banded for study purposes. Cowbird parasitism on vulnerable species cannot be systematically brought under control without the help of trapping.

## Collecting Data

As with any scientific endeavor, cowbird trapping requires that data be collected in order to determine how effective it is. Collecting data also allows scientists to track the movements of banded birds, and hopefully to find new ways to reduce the parasitism rate that has caused many songbird populations to decline. By participating in this project landowners have the opportunity to help songbirds, and make a genuine contribution to the threatened and endangered wildlife in Texas.

Once the data has been collected, landowners should keep a copy, and forward a copy to **Texas Parks and Wildlife**. This allows **TPW** to monitor the total numbers of birds being trapped and the locations of the traps. **All data and information submitted is strictly confidential** Data to be collected should include the date, the number and type of non-target species that might get into the trap, the number of males,

the number of females, and the numbers off any banded birds that might be caught. *Banded birds are to be released* after the data is collected. While any data sheet will do, a data page is included in this material that may be copied and used immediately.

### **Selecting a Trapping Location**

The location of the trap is critical to maximize cowbird capture and to minimize non-target birds being caught. The idea is to put the trap in a place that is as attractive to cowbirds as possible, without being disruptive to other species. Ideally the trap should be located in areas that include the following:

- Close to where cattle or other livestock graze.
- In open pasture, away from any brush, and in low grass.
- The trap should be readily accessible to vehicles, even after heavy rain.
- Water and some perching snag (dead trees) nearby.

### **Site Precautions**

Even on a perfect location site there are precautions that should be taken to insure the safety of landowners and others participating in cowbird trapping.

One of the hazards to be aware of is that of predators. Any mammal, bird, or reptile that eats birds will be attracted to the traps in search of an easy meal. Keep the grass around the trap short. This will not only make it easier to spot snakes, but it will also make it more attractive to cowbirds. Raccoons and skunks will dig under the traps if precautions are not taken to keep them out. Owls and hawks also try to swoop down on the birds inside the trap. Fire ants can pose an additional hazard. Before using fire ant bait, check with your local Extension Service office for application recommendations. Always be sure to read and follow pesticide label directions. Never use any insecticides in the trap itself.

**TRAP OPERATION: Traps are permitted to operate from March 1 to May 31 ONLY. This is to avoid incidental catch of non-target species. After May 31, fledglings of beneficial species such as cardinals, mockingbirds, buntings, and finches are most abundant and are more likely to be accidentally trapped.**

### **Setting up the Trap**

Erect the trap on a level site with no gaps between the frame and the ground. Use a shovel to fill in any gaps, if necessary.

Place a one gallon poultry waterer on level ground inside the trap. Scatter about a half a coffee can of cleaned milo (grain sorghum) on the ground, being careful to avoid getting it in the water. Do not feed milo during rainy weather because the birds do not like soggy grain. Wait until the ground has dried up before scattering it out again.

Since cowbirds are gregarious birds, the traps work best if about 10-15 live cowbirds are present to act as decoys. When first starting a trap without decoys, be patient. If cowbirds are in the area, they'll find and enter the trap.

Use a large minnow dip or trout net to catch birds in the trap. You must **immediately release** any non-target bird species. Any bird not a cowbird is a non-target bird. Always remove and dispose of any dead or injured birds (usually a result of

avian predator attack on the trap). The most common species of non-target birds that have been found in traps are mockingbirds, cardinals, various sparrows, grackles, blackbirds, and loggerhead shrikes. Consult a bird field guide to help you identify these species. Non-target birds will enter the traps for a variety of reasons. Some are attracted to the grain, some for company, and still others just out of curiosity. Putting a board across one side at the top to provide shade to trapped birds is recommended. Humanely treating birds while in the trap and humanely euthanizing birds is important.

### **Euthanizing Cowbirds**

*This is the real job of protecting songbirds from nest parasitism. Whichever method is used to kill cowbirds, it must be humane, fast, and certain. The recommended method is cervical dislocation, or separating the vertebra.*

*Cervical dislocation: Hold top of neck between thumb and forefinger, grab head with other hand, turn and lift until you feel the cervical vertebrae detach from the head – HINT: hold the bird away from you when you do this the first few times until you have the “touch”. A catch box, net, gloves, and a light for night time are useful items to have on hand.*

*Alternative Dispatch Methods: Carbon dioxide (CO<sub>2</sub>) gas in a 5-gallon bucket may be used to euthanize brown-headed cowbirds. Use dry ice as the source of carbon dioxide. Cut a hole in the top of the bucket, cover opening with a piece of inner tube, or similar material, that has a slash in it to facilitate putting birds inside. Birds must not be touching the dry ice! Birds should be dead within 20 seconds.*

### **Taking Traps out of Operation**

Because cowbirds are a native species in North America, they are protected under the Migratory Bird Treaty Act. However, there are exceptions to this law for acts of depredation by a few select species. Under the **Texas Parks and Wildlife Code**, Section 64.002(c) brown-headed cowbirds are included among this small group of eight non-protected bird species that “may be killed at any time and their nests or eggs may be destroyed.” State regulations may not supersede federal regulations, so it is important that all participants in this project follow the protocols outlined here in this module. Again, remember that no traps are to be in operation either before March 1, or after May 31.

If it is not possible to remove the trap to a location where it can be stored under cover, then certain precautions must be taken because birds, including non-target species, will tend to enter the trap. The traps may be taken out of operation by placing boards over the entry slots or by securing the door in an open position. Be sure to remove all cowbirds, and release any banded birds, disposing of any dead or injured birds.

### **Reporting the Data**

Be sure to record all data on birds captured on an approved data form and forward copies to Texas Parks and Wildlife in Austin. This is a necessary part of your

permit requirements. Landowners who are certified through Parks and Wildlife and actively participating in trapping brown-headed cowbirds will be provided with self-addressed envelopes and data forms on a weekly basis. **ALL information submitted to TPW is strictly confidential.** Submit data to:

Texas Parks and Wildlife  
Private Lands and Habitat Program  
4200 Smith School Road  
Austin, TX 78744

# COWBIRD TRAPPING DATA SHEET

NAME\*: \_\_\_\_\_

\*Optional, but desired. Information provided is strictly confidential.

TRAP # \_\_\_\_\_

LOCATION: \_\_\_\_\_

Date: \_\_\_\_\_

Females	
Males	
Band Numbers (If Any)	
Non-Targets (record # and species)	_____
Comments	

Date: \_\_\_\_\_

Females	
Males	
Band Numbers (If Any)	
Non-Targets (record # and species)	_____
Comments	

Date: \_\_\_\_\_

Females	
Males	
Band Numbers (If Any)	
Non-Targets (record # and species)	_____
Comments	

Date: \_\_\_\_\_

Females	
Males	
Band Numbers (If Any)	
Non-Targets (record # and species)	_____
Comments	

Date: \_\_\_\_\_

Females	
Males	
Band Numbers (If Any)	
Non-Targets (record # and species)	_____
Comments	

Date: \_\_\_\_\_

Females	
Males	
Band Numbers (If Any)	
Non-Targets (record # and species)	_____
Comments	

Submit Data to: Texas Parks and Wildlife, Private Lands & Habitat Program, 4200 Smith School Rd., Austin, TX 78744

## Materials List for 6x8 Portable Wood Cowbird Trap

Number	Description	Comments
16	2x4x8 (treated)	Rip 2x4 into 2x2
2	Sheets ½" CDX plywood	1 sheet is for slot assembly, 1 sheet is to cut up for gussets.
64 linear ft	½" mesh hailscreen	Bought in 100 ft. rolls
1 pair	Tight pin hinges (3")	Door hinges
1	Screen door-handle	Outside of door
1	Galvanized hasp (4½")	Use with padlock for security
1	Screen door latch	Used on inside of door
14	10"x12" shelf brackets	Used to square panels (2 per panel)
125 (approx)	1" drywall screws	Field assembly of slot assembly, attaching shelf brackets to panels.
50 (approx)	3" galvanized deck screws	Field assembly (panel to panel)
300 (approx)	1½" pneumatic staples	Used attach gussets
600 (approx)	1 pneumatic staples	Used to attach screen to panels
300 (approx)	½" staples	Used to attach screen to slot assembly

### Recommended Tools For Construction

#### Shop Assembly of Panels

Table saw – for ripping 2x2  
 Chop saw – for cutting boards to length  
 Electric hand saw – for cutting out gussets and slot assembly  
 Retractable rule – for measuring dimensions  
 Electric or cordless drill/driver – for driving screws  
 Pneumatic or electric nibbler – for cutting hail screen  
 Pneumatic stapler – for attaching gussets and wire  
 Pneumatic nailer – for assembly of panels  
 (optional but helpful – Panels can be assembled with 3" deck screws if nailer is not available.)

#### Field Assembly

Cordless drill/driver – for driving screws  
 Bar of soap – to lubricate screw threads  
 Hand stapler – to secure wire to ends of drop entrance  
 Step ladder – for attaching top panels

# Construction Tips

- Use treated lumber throughout. Added initial cost is compensated for by longer field life and reduced maintenance.
- Don't rip lumber until you are ready to start construction. Ripped lumber will bow and twist if allowed to sit for several days.
- Use a shelf bracket on diagonal corners to square each panel before attaching gussets. To cut gussets, lay out sheet of plywood in 12" squares, then draw diagonals across the square. A sheet of plywood will make 64 gussets.
- Gussets go on one side of panel, hailscreen attaches to the other side. For side and top panels, wire will end up being on the inside on the panel. This prevents birds from roosting on framework next to wire where they are prone to predation. **Exception:** End panels are constructed the same way, but during final trap assembly, the wire goes on the outside, because the drop entrance attaches to horizontal members for structural stability.
- This pattern is designed to use 48" wide hailscreen to maximize efficiency. Internal cross members are placed to allow for slight overlap. Wide hailscreen will probably not be readily available in stock, but any building supply can order it. Use of narrower hailscreen requires repositioning of tack strips, and results in higher lumber use.
- To maximize shop efficiency: cut gussets; rip lumber; pre-cut lengths; cut out slot assembly; assemble side, top, and end panels; attach hailscreen; final assembly. When building multiple units, performing similar actions for several traps at the same time will allow you to develop an assembly line process that cuts construction time per unit.
- **Slot width of 1.25 inches in slot assembly is critical.** Wider slots will increase non-target captures, including small raptors, which will feed on your decoy birds. Escapes by females may also increase with wider slots.
- Side panels attach to the outside of end panels. Nothing else will fit if you attach ends outside.
- During final assembly assemble in this order: end, side, side, top, top, dropping slot assembly (3 pieces), then finish with the other end.





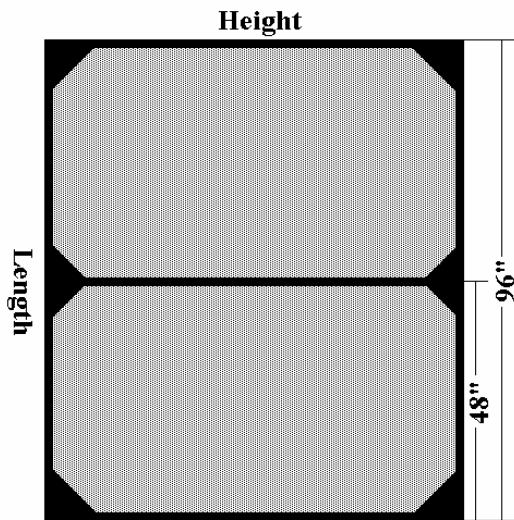

Left Side Panel (same as right panel)

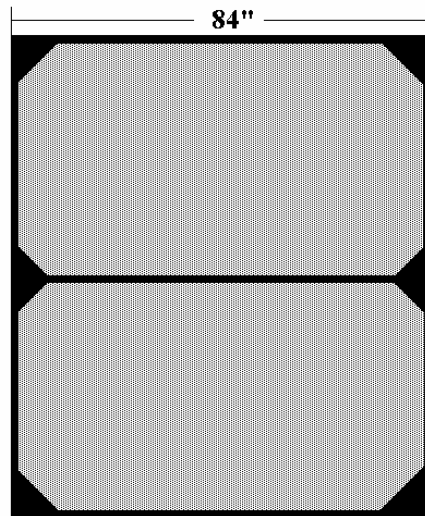

Right Side Panel

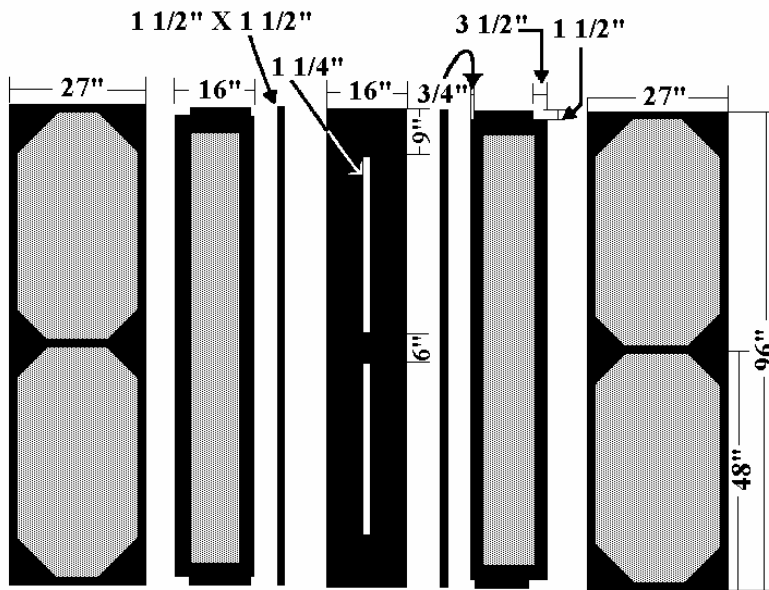

Top Panel/Slot Assembly

End View of Top Panel/Slot Assembly

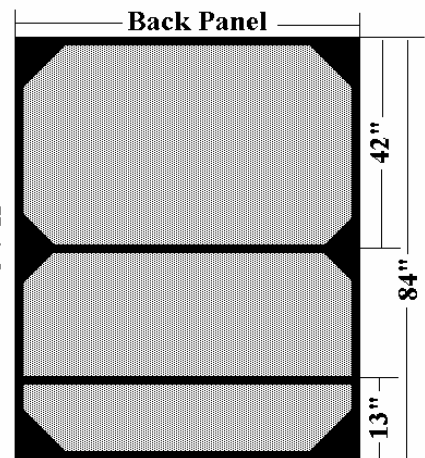

Back Panel

# Cowbird Trap Plans

Plans developed by Fort Hood Environmental Division.

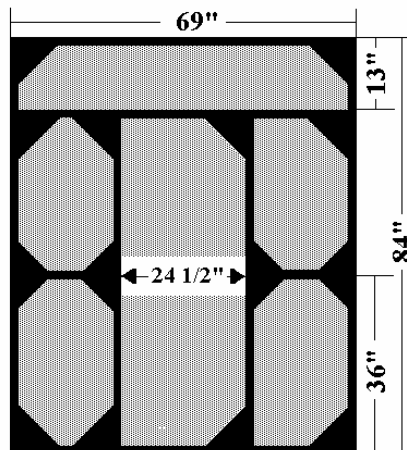

Front Panel

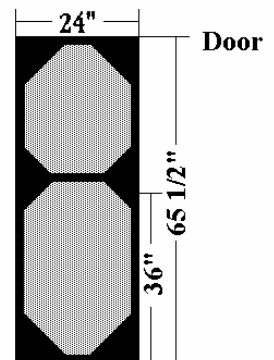

Door

# Materials List for 6x8 Portable Metal Cowbird Trap

Number	Description	Comments
300	1 ½" fender washers*	attach wire to the trap frame
210 ft.	1 ½" 14 gauge square tubing	frame
16 ft.	1 ½" x 1 ½" x ⅛" angle iron	trap funnel base
15" w x 94 ½" lg	⅛" plate*	funnel entrance floor
2	2" weld-on hinges*	door hinge
1	weld-on door latch*	used to keep door secured
50 ft. of 48"	½" hardware cloth	bought in 100 ft. rolls
40 ft. of 36"	½" hardware cloth	bought in 100 ft. rolls

## Recommended Tools:

220 amp electric wire feed welding machine	Vise-grip pliers
Oxyacetylene cutting torch or pipe saw	6 3 or 4 inch C-clamps
Electric drill and metal bits	Metal measuring tape
Driver for self-tapping metal screws	Wire brush
Hacksaw	Wire shears or tin snips
Hammer	Metal dirt rake

## Order of Construction: *(Refer to diagram for placement before welding)*

### Sides (Cuts necessary for both sides)

- 2 cuts 96" of 1 ½" x 1 ½" 14 gauge square tubing (top of side panels).
- 2 cuts 96" of 1 ½" x 1 ½" heavy gauge square tubing (base of side panels).
- 4 cuts 81" of 1 ½" x 1 ½" 14 gauge square tubing (vertical corner posts).
- 2 cuts 93" of 1 ½" x 1 ½" 14 gauge square tubing (center braces).

### Front

- 2 cuts 72" of 1 ½" x 1 ½" 14 gauge square tubing (door headers).
- 1 cut 72" of 1 ½" x 1 ½" heavy gauge square tubing (base piece).
- 2 cuts 11" of 1 ½" x 1 ½" 14 gauge square tubing (bracing over the door).
- 2 cuts 22 ¼" of 1 ½" x 1 ½" 14 gauge square tubing (mid-section bracing by door).
- 2 cuts 68 ½" of 1 ½" x 1 ½" 14 gauge square tubing (doorframe).

### Door

- 3 cuts 21" of 1 ½" x 1 ½" 14 gauge square tubing (top, middle, bottom bracing).
- 2 cuts 68" of 1 ½" x 1 ½" 14 gauge square tubing (sides of door).

### Back

- 3 cuts 72" of 1 ½" x 1 ½" 14 gauge square tubing (top, center frame pieces).
- 1 cut 72" of 1 ½" x 1 ½" heavy gauge square tubing (base piece).
- 2 cuts 11" of 1 ½" x 1 ½" 14 gauge square tubing (top bracing pieces).

## Top

2 cuts 93" of 1 1/2" x 1 1/2" 14 gauge square tubing (upper frame for trap funnel).  
2 cuts 93" of 1 1/2" x 1 1/2" x 1/8" angle iron. (lower trap entrance plate supports).  
15" wide x 94 1/2" long 1/8" plate (trap entrance plate). Cut two openings 36 1/4" x 1 1/4" as shown in the diagram. *The exact 1 1/4" width of each opening is critical. (Note: If desired, this plate can be made of wood, rather than metal.)*

## **Wire Mesh covering**

Center the wire at the door and wrap it around the entire trap, using a dirt rake to pull the wire tight. Don't forget to cover the floor of the trap (this will help keep predators out). Attach the wire to the frame with fender washers and self-tapping screws placed every 12 inches apart.

Door: 1 piece 67 3/4" x 23 1/2". Trim to fit.

### *Placement Notes:*

- A. 1/4" gap on hinge side of door between door and frame.
- B. Hinge starts 10" from the top.
- C. Hinge starts 10" from the bottom.

## **\*ALTERNATE CONSTRUCTION METHODS**

### Attaching Wire Mesh (Alternate Method)

If desired, the screen mesh can be attached to the trap using 130 feet of 1" x 1/8" strap, and 275 self-tapping metal screws. Make the following cuts if this method is used:

Front: 2 – 74 1/2"	Both Sides: 6 – 95 3/4"
2 – 23 1/2"	4 – 6"
2 – 27 1/2"	
2 – 11"	Rear: 3 – 74 1/2"
	2 – 11 1/2"
Door: 3 – 23 1/2"	1 – 19"

2 – 21" (upper sides)      Center Trap Angle: 2 – 93"  
2 – 42 3/4" (lower sides)

Hold all screen in place with 1" x 1/8" plate with screws placed every 6 inches.

### Alternate Door Hinges and Latch Construction:

*Note: Put door latch on first, then install frame latch to fit.*

1 ft. of 1" x 1/4" strap  
2 ft. of 3/8" tubing  
2 ft. of 7/16" rod

### Make the following cuts:

4 cuts 2" of 3/8" tubing (door hinge part)

2 cuts 5" of 7/16" rod (door hinge part)  
1 cut 7" of 1" x 1/4" strap (door latch)  
1 cut 5" of 1" x 1/4" strap (on door)  
1 cut 2" of 3/8" tubing (on door)  
1 cut 3 1/4" 7/16" rod

Alternate Trap Entrance Plate:

2 pieces of plate 7" wide x 94 1/2" long, separated by 1 1/4" inches that will form the opening. *The exact 1 1/4" width of the opening is critical.*



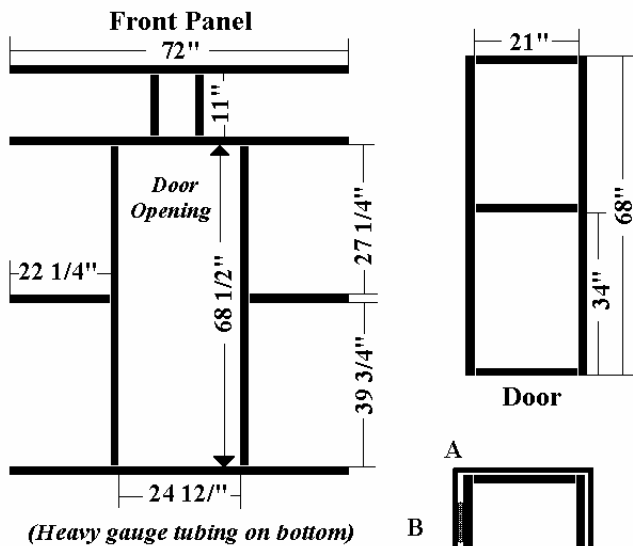
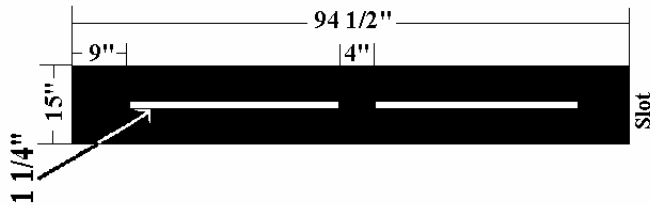
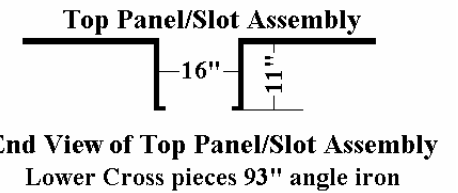
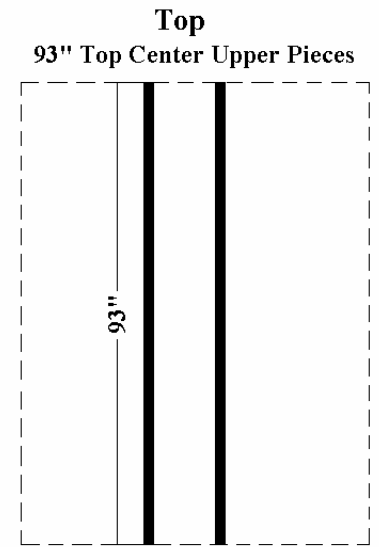
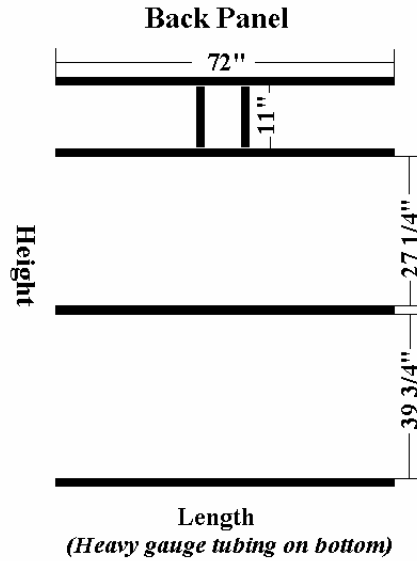
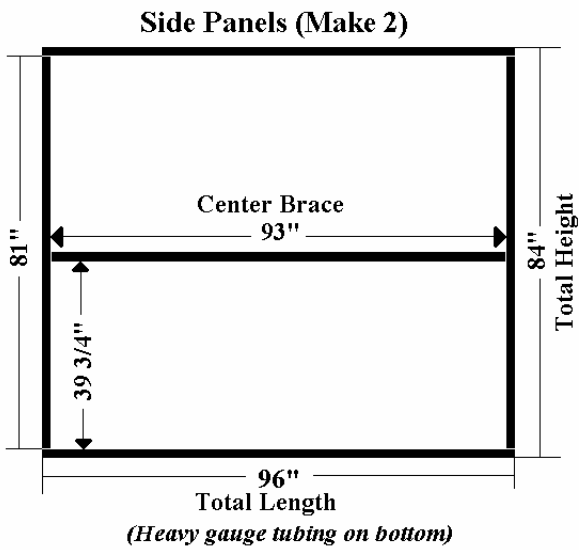

**Door Latch Assembly**

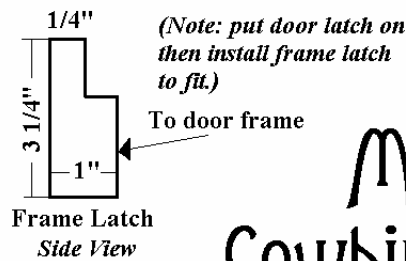
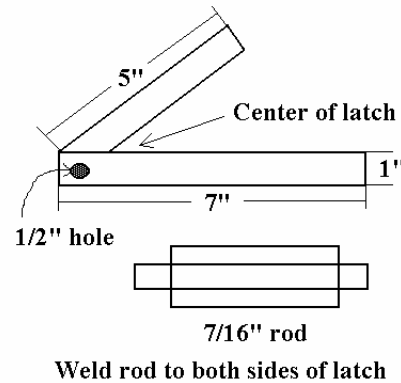

- A. 1/4" gap between hinge side of door between door and frame.
- B. Hinge starts 10" from top.
- C. Hinge starts 10" from bottom.

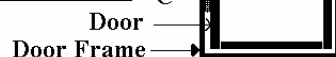

# Metal Cowbird Trap Plans

## Resources

The following organizations and their web-sites are recommended as sources of further information on cowbird parasitism, cowbird trapping, and other wildlife information.

**Central Texas Cattlemen's Association.** Steve Manning, Vice President. 4125 FM 116, Gatesville, TX 76528.

**Kerr Wildlife Management Area.** Route 1, Box 180, Hunt, TX 78024. Ph. 830-238-4483.

**The Nature Conservancy of Texas.** P.O. Box 1440, San Antonio, TX 78295-1440.  
[www.tnctexas.org](http://www.tnctexas.org)

**Texas Department of Agriculture.** P.O. Box 12847, Austin, TX 78711. Ph. (512) 463-7476. [www.agr.state.tx.us](http://www.agr.state.tx.us).

**Texas Farm Bureau.** P.O. Box 2689, Waco, TX 76702-2689. Ph. (254) 772-3030.  
[www.txfb.com](http://www.txfb.com).

**Texas Parks and Wildlife.** 4200 Smith School Rd., Austin, TX 78744. Ph. (800) 792-1112. [www.tpwd.state.tx.us](http://www.tpwd.state.tx.us).

**Texas Wildlife Association.** 401 Isom Rd., Suite 237, San Antonio, TX 78216.  
Ph. (210) 826-2904. [www.texas-wildlife.com](http://www.texas-wildlife.com).